

CVR DE Driver’s Guide, 2019
Welcome to the Connecticut Valley Region (CVR) Driver’s Education Program!

We’ve conducted events at Lime Rock Park, Watkins Glen and other tracks for many years. Our members have logged countless hours as workers, instructors, drivers and organizers. And we’re known for the quality and safety of our program.

Our goals are: to help drivers learn the capabilities of their Porsches and the dynamics of driving at speed in a controlled and safe manner; to create opportunities to practice and improve driving skills; and, of course, to have fun. Driver’s Ed is *not* a competitive or timed event, and it is *not* a practice for such events. The driving techniques described in this guide are intended for use at a racetrack and should not be practiced on public roads.

This guide reflects the input of CVR members having decades of combined Driver’s Ed involvement. It was prepared primarily for beginners and other new participants at Lime Rock Park, and its purpose is to take some of the mystery out of the initial experience. Supplemental information about our Driver’s Ed program at other tracks is available through our website (www.cvrpca.org).

Table of Contents

I. BEFORE GOING TO THE TRACK	1
II. ARRIVAL, CHECK-IN AND DRIVER’S MEETINGS.....	4
III. RUN GROUPS, TRACK SESSIONS AND WORK ASSIGNMENTS	7
IV. TRACK DRIVING BASICS.....	13
APPENDIX A: GLOSSARY.....	20
APPENDIX B: 2019 CVR DRIVER’S EDUCATION REGULATIONS.....	22
APPENDIX C: LIME ROCK AREA MAP	25
APPENDIX D: LIME ROCK TRACK LAYOUT.....	26
PALMER MOTORSPORTS PARK TRACK LAYOUT	29
APPENDIX E: FLAG STATION COMMUNICATION INSTRUCTIONS & FLAGS AND THEIR USE.....	30
APPENDIX F: WHAT TO BRING AND WEAR.....	32

To facilitate cross-referencing, **Glossary** terms are underlined the first time they appear in the text.

Given its introductory emphasis, you’ll no doubt have questions after reading the Guide. Most can be answered when you get to the track. However, for special inquiries regarding administration and logistics, please contact the Registrar. If you have questions regarding other aspects of the program that can’t wait for the track, please contact the VP-Driver’s Ed. Phone numbers and email addresses are listed in *The Challenge* and are on our website (www.cvrpca.org).

We’re happy you’re joining us, and we look forward to seeing you at the track.

Connecticut Valley Region
Driver’s Education Committee
Jan 2019

I. BEFORE GOING TO THE TRACK

There aren't many formalities, but thoughtful preparation will enhance your Driver's Ed experience.

Car Specifications. Driver's Ed is generally for Porsches only. As noted in **Appendix B**, there are special requirements for certain models, as well as for specific equipment items such as fire extinguishers. Mufflers meeting Connecticut State and Lime Rock Park noise abatement standards are required for all cars. If you're uncertain about how the rules apply in your case, please contact the Registrar, the VP-Driver's Ed or an approved tech inspector.

Application. Registration is through the web site (www.clubregistration.net). The Website will have all the information to walk you through the process. Preferred payment is by Pay Pal. A confirmation noting your acceptance into the event will be e-mailed to you when accepted. Run Groups tend to fill up quickly so don't wait.

Tech Inspection. Prior to the Driver's Ed, your Porsche must be checked by a CVR inspector (see Driver's Education page of web site for listing). This should be done between two and four weeks – but never more than four weeks – prior to *every* Driver's Ed event in which you'll drive the car. This avoids unnecessary delays and disappointments by ensuring that your car meets the basic safety requirements – e.g., mechanical operation, tread wear, etc. – before you get to the track. Print out a 2019 tech form from the Driver's Ed tab of the web site and bring it to your inspection. You'll receive a completed and stamped Tech Sheet that must be brought to the track. A sample Tech Sheet showing what will be checked is also found on the Web site.

Equipment and Clothing. Required and suggested items are listed in **Appendix B** and **Appendix F**. We just want to emphasize a few points that have confused first-time drivers in the past.

- **Helmets.** As noted in **Appendix B**, a Snell 2010-rated or later model helmet is required (plus a face shield or goggles if you have an open car). Snell uses a similar numerical rating system for motorcycle (“M”) and auto (“SA”) helmets. Either designation is permissible for Driver's Ed, but “SA” is preferable if you're making a special purchase. If you don't own a helmet, a limited number of loaners are available through the club, but please check with the Registrar in advance.
- **Driving Shoes and Gloves.** Neither is essential. However, your track shoes *are* important. They should provide good support, have rubber soles, attach securely to your feet and be flexible enough to help you feel the pedals. Sneakers are fine, but avoid the kind with soles extending beyond the sides of the feet, as they can reduce pedal feel and make certain maneuvers difficult. Open shoes will not be allowed.
- **Neck Supports.** Even the latest space-age helmets can feel heavy at the end of the day. While not required, a number of drivers use neck supports. These are padded rings that fit around the neck just below the helmet. They tend to reduce fatigue and lend extra support.
- **Clothing.** Driving suits aren't required for the CVR Driver's Ed program. However, you must wear pants and shirts/sweaters/jackets made of natural (i.e., non-synthetic) material. Don't forget to factor in the seasonal variations, as you'll be driving with *both* side windows down (rain or shine).
- **Storage Containers.** As you'll see in **Section II**, one of the first things you'll do at the track is empty the loose contents of your car. It's a good idea to bring a weatherproof tarp (or

ground cloth) and a plastic container to store your belongings, as most tracks do not have covered storage areas.

Safety. You'll hear this word a lot because it's our main priority. We expect drivers and guests to do their part to make the event safe for themselves, other drivers and guests, volunteers and workers. Driver's Ed demands total physical and mental concentration that can be very fatiguing. It's extremely important to arrive refreshed, clear-headed and ready to go. As noted in **Appendix B**, alcohol consumption is prohibited -- guests as well as drivers --until the last Track Session of the day is completed. Banned substances of any kind are never permitted, of course. Consumption of alcohol or banned substances will result in ejection from the event.

There is constant traffic in and around the Paddock area, as cars Stage and return from their Track Sessions. Pets are not allowed at Lime Rock. Persons under age 18 are *not* allowed on the track, in the pit area or at Flag Stations. Please consider this when making your plans.

Other Considerations

- **Individual Responsibility.** As with other programs in which you drive your car, each participant is responsible for meeting all the customary requirements such as age, license, insurance, ownership registration, sound physical and mental health, etc.
- **Passengers.** For purposes of instruction only, CVR approved Instructors may ride in a student's car (and vice versa, at the discretion of the instructor) provided both occupants are registered for the event and the same type of restraint system (seats, seat belts, roll bars, cages, etc.) is available to both. Pro-coaches, approved by CVR, may register and ride in an advanced driver's car (non-instructed student). Other passengers are *not* permitted on the track.
- **Inclement Weather.** The event will be held rain or shine (unless otherwise determined by the VP-Driver's Ed). In the rain, you can lose 30% or more of straight-line traction and 50% or more on corners. "Ponding" may occur in various areas of the track and extra caution is necessary. Driving lights are recommended as well. Snowy conditions sometimes can cause cancellation of a track day in early spring. Check our web site (www.cvrpca.org) for last minute information.
- **Food and Beverage.** There is generally a snack bar in the Paddock area at most tracks that is generally open until mid-afternoon, but many drivers bring their own food. Remember to have plenty of liquids -- especially during warmer months -- as driving and being in the sun can be very dehydrating.
- **Accommodations.** If you plan to stay overnight, there are a number of hotels, inns and bed & breakfasts to meet your needs. Due to space limitations -- and popularity -- it's wise to book well in advance. A listing is available at the Lime Rock Park link on CVR's website.
- **Neighboring Communities.** By complying with the strict speed limits and other local ordinances, you'll support our efforts to enjoy continued use of the track.

II. ARRIVAL, CHECK-IN AND DRIVER'S MEETINGS

Registration generally begins at 7:00 AM, and it's a good idea to arrive early.

Before Arrival at Lime Rock Park

- If your car is equipped with “keyed” lug nut locks (e.g., pre-1995 vehicles), the locks (but *not* the underlying lug nuts) should be removed while you're at the track. If your car has “coded” lug nuts, it's advisable to replace them with standard lug nuts while you're at the track.
- Check tire pressures and lug nut torque settings while the car is cold. If you're uncertain about the correct pressures or settings for your Porsche – or if you lack the equipment or know how – talk to experienced drivers with a similar car or consult one of the tech inspectors. At a minimum, bring a tire gauge because you may need to make adjustments during the day. There is “air” at the track.
- Your gas mileage will be very poor on the track, so top off the tank if possible. There are a few stations within a 5-10 mile radius of Lime Rock Park that are open early. Gas pumps (adjacent to the Paddock area) are open during the day and accept credit cards. Race gas is expensive. Besides 110 Leaded and 100 Unleaded, Lime Rock also has 94 Unleaded. Otherwise, you'll have to leave and re-enter the Park to get gas during the day.

Arrival and Check-In

- Enter Lime Rock Park through the Infield Entrance (see **Appendix C** and **Appendix D**).
- Drive to the Main Gate, where you'll sign the Lime Rock Park waiver. Then follow the road across the bridge. Bear left down the hill and then right into the Paddock area. Park your car in a location that permits easy access throughout the day and has space to store your belongings. The Paddock speed limit is 5 mph, and traffic flow is one-way (counterclockwise).
- There should be *nothing loose* in the trunk or passenger compartment that can shift around – or become airborne – while you're on the track. When you've found a parking spot, the general rule is to *remove everything* that's not permanently attached -- floor mats, luggage, glove box contents, telephone receivers, etc. Even the fuzzy dice. There are two exceptions:
 - A properly attached fire extinguisher – mandatory for Red, Black and White Run Groups.
 - A securely affixed spare tire (but *not* the tools) in the trunk.

If you have 4" or larger magnetic or stick-on numbers that meet CVR specifications, place them securely on the side doors. Be aware that not all magnetic numbers stay on at track speeds, so they may need to be secured with tape (i.e., racing tape that is safe on paint). Your assigned car number must be on the side of your car. The numbers should be 4" or greater in size, either stick-on or shoe polish, and should be on your car before you go through morning tech line. DE participants are assigned a 3 digit number. You can also opt to select a 3 digit number that you like if it is not already reserved by a fellow driver.

Note: Your car number was assigned when your first application for the driving season was accepted, and it should be noted on the confirmation you received e-mail. Once a car number is assigned to you, it will be yours as long as you're active in CVR.

- You may go to either Registration (Michelin Building) or the Final Tech Inspection first, but both must be completed prior to the driver's and instructors meetings (approximately 8:00 AM).
 - *Registration:* Proceed to the Michelin Building. There you'll sign the CVR waiver and receive your Work and Run Group assignments for the day and a color coded wristband of your run group color. It must be worn in order to get onto the track. Bring your driver's license.

Note: If two drivers will be using one car (in 2 different Run Groups) that day, both must register. If you're enrolled in a two-day program, you'll register each day.

- *Final Tech Inspection:* The line forms through the gate west of the Michelin Building. Have your completed Tech Sheet handy to leave with the inspectors. Also bring the helmet for each driver using your car that day. After you receive a tech sticker and a run group dot for the car, return your car to its parking spot.

Note: The Tech line normally closes at 8:00 AM. If you're enrolled in a two-day program, Final Tech is required each day.

- If you haven't done so already, check your seat and mirror adjustments. Also go over the car to make sure it's track ready – windshield clean, oil to the proper level, side windows down, sun roof closed, top up, etc.

It might sound like a lot to do in a short time, but there usually aren't many delays if everyone arrives on time. It's a great way to meet new friends. And don't hesitate to ask questions, as we think you'll find your fellow club members to be very helpful and willing to explain.

Driver's Meetings and Flag Safety Instruction

- **General.** At approximately 8:15 AM, there will be two mandatory meetings: one for all non-instructor drivers conducted at Pit Lane (see **Appendix D** for location) and another for instructors conducted upstairs in the Michelin Building. Stay alert for scheduling announcements. During the driver's meeting, there'll be a review of safety procedures, passing rules, flags, etc. At the end of the driver's meeting, if you're assigned to the green or yellow run group and have been assigned an instructor, you'll receive a card with the instructor's name and car description, and on the back a short questionnaire, rating the instructional program, to be completed after your last track session and returned to the Chief Instructor. There will be a box for the card on the ground floor of the Michelin Building.
- After the driver's meeting, find your instructor (if applicable) to get acquainted, go over questions and arrange where to meet when it's your turn to drive on the track.
- All requests to be moved to a lower (less experienced) Run Group will be promptly considered. See the VP-Driver's Ed or Chief Instructor if you have a question.

III. RUN GROUPS, TRACK SESSIONS AND WORK ASSIGNMENTS

The remainder of the day will consist of three main activities: driving on the track; a work assignment to increase your track awareness and contribute to the safety of other drivers; and waiting.

Run Groups

Like most PCA Driver's Ed programs, CVR assigns each driver to one of five color-coded driving groups: Green, Yellow, White, Black and Red. Run Group assignments – based on skill and experience – are made when the Registrar processes enrollment applications. The Green and Yellow Groups are for novices. The White and Black are for more experienced drivers and the Red Group is for instructors only. Sharing of a vehicle in 1 Run Group is not allowed.

Your assignment will be posted on the email confirmation that you receive when you are accepted into the event and also given to you at registration each morning. If this is your first Driver's Ed experience, you'll normally be assigned to the Green Group. All beginning drivers will have an instructor to ride with them for the day. More experienced drivers -- who are new to Lime Rock Park -- also may have an instructor to acquaint them with the driving Line. Yellow students will be permitted to run alone for that day (i.e., "signed-off") only after their instructor has approved them as having displayed the proper skills, track familiarity and attitude.

Track Sessions

Each Run Group normally will have four Track Sessions during the day, each lasting about twenty minutes (depending on weather and other factors). Staging between Sessions and the late afternoon curfew at Lime Rock Park leave little margin for delay without losing driving time. That's why it's so important to arrive on time and to be prompt throughout the day.

Driving fundamentals -- including techniques to correctly enter, negotiate and exit the track -- are covered in **Section IV**. In this Section, we'll acquaint you with the basic sequence and procedures for Track Sessions. Please consult **Appendix D** if you're unfamiliar with the track layout.

- **Staging.** A **Pit-In Marshal** will signal you onto Pit Lane when it's safe. Since cars entering and leaving the track all use Pit Lane, pay close attention to the Marshal. Depending on your arrangements with the instructor (if applicable), he or she may accompany you or meet you in Pit Lane. Pit Lane speed limit is 5 mph.

At the end of Pit Lane, you'll see a **Pit-Out Marshal**. Your Group will line up single file in front of the Pit-Out Marshal on the left side. Once in line, make a final check – side windows down, sun roof closed, top up, etc. -- as applicable. Make sure you're comfortable with the seat and mirrors, and check that your seat belt and helmet are securely fastened. Your instructor will have a two-way radio to facilitate communication on the track –check the hook-up.

Note: If your instructor plans to take the first few laps to show you the Line -- which is the norm with new drivers -- he or she will be in the driver's seat at this point.

A few butterflies are normal. So take a deep breath. Focus. Ask questions. And have fun as you experience firsthand what Porsches are all about.

- **Track Entry.** When Control is satisfied that the track is clear, the Pit-Out Marshal will signal the cars in your Group onto the track. Wait for the Pit-Out Marshal to signal *your* car before entering the track. If you're toward the back of the line, other cars may be completing their first lap before you enter the track. The Pit-Out Marshal has the best field of vision to know when it's safe. However, it's *your* responsibility to make a safe entry. Watch your mirror carefully. When entering the track, stay to the right until the first turn.
- **Direction Of Travel.** Traffic flow on the track at Lime Rock is *always one-way and clockwise*.
- **Warm Up Lap.** This is the first lap or two of each Track Session. A Standing Yellow Flag is usually displayed. Take it easy. Let your car, brakes, oil and yourself warm up. Get acclimated to current track conditions. During these Yellow Flag laps, there is no passing. You'll know the warm up period is over when you see the Green Flag displayed at Start-Finish and/or the Standing Yellow Flag is withdrawn at all Stations.
- **Mechanical Checks.** Learn to glance *briefly* at the gauges from time to time to make sure your engine temperature, oil pressure and fuel level are within acceptable limits. A good time to do this is on the Main Straight when the car is well balanced and moving straight ahead -- not during turns or passes. Note how the brakes feel throughout the day. If something doesn't look or feel quite right, stay on Line and come into the pit area the next time you pass the Downhill Turn.
- **Passing Rules at Lime Rock Park.** See also **Section IV (Passing Maneuvers)**.
 - The Track Chair will announce permissible passing zones for each Run Group during the morning driver's meeting.
 - All passing is usually done on the right (except for between Big Bend and the Left Hander, where passing may occur either on the left or right).
 - Passing is permitted *only* when the driver in front gives a clear signal – To be passed on the Right, the signal is -- left arm raised out the window and pointing over the roof of the car. To signal to be passed on the Left -- your left arm points straight out the window. *Each car* you wish to pass you requires a separate signal. The signal you are giving is pointing to the side of your car that you want the overtaking car to pass on.

- In general, passes should be initiated at the beginning of the straight and must be completed before the Turn-In Point. Exercise additional discretion on the No-Name Straight (the Line transverses the track from left to right).
- Once the Checkered Flag is shown at Start-Finish (see **Cool Down Lap** bullet below for additional explanation).
- Passing is *not* permitted under the Yellow Flag, after the Checkered Flag or in certain other flag situations (see **Appendix E**).
- **Signals.** Acknowledge Black, Checkered, and Passing directed your way by waving (but not out the window), or by blinking your headlights. The hand signal for exiting the track is a raised fist out the driver's window, as noted below in the **Track Exit** bullet.
- **Incidents.** See also **Section IV (Avoiding Difficulties)**. If there's contact or you go off the track (4-OFF), *stay in the car. If you go off, don't re-enter the track until directed to do so by flaggers or other track personnel.* Spins and off-track excursions (2-OFF as well as 4-OFF) are a mandatory Pointing Black Flag (i.e., pit stop). Don't wait for the Black Flag, however. Come right into the pit area at the completion of your *current* lap. Upon entering Pit Lane, proceed to the Steward's pit box at the base of the Michelin Building. Two Pointing Black Flags for separate driving infractions can result in canceling your further driving (but not the Work Assignment) for that day.
- **Intermediate Pit Stops.** There may be times when you'll want to come into the pit area while your Track Session is in progress. You *must* make a pit stop if you're Black Flagged (something wrong with your driving or your car), you spin, or you have 2-OFF or 4-OFF at any point on the track. Also come in if you hit something, your car isn't operating correctly, or you become tired. If your pit stop is for mechanical reasons, it will be necessary to have the car re-teched before going back on the track. If you feel something is wrong, don't wait to be summoned by the Black Flag. Go into the pit area on your own and check things out. We want everyone to take their cars (and themselves) home in the same condition they arrived.

If you make a pit stop and wish to re-enter the track while your Session is still in progress, the same procedure applies as before. Line up along the left side of Pit Lane in front of the Pit-Out Marshal, and wait for the signal. Remember, it's up to *you* to ensure safe entry onto the track, so watch your mirror.

- **Cool Down Lap.** This occurs at the end of each Track Session. Its purpose is to permit your engine and brakes to return to more normal operating temperatures before parking. Maintain your concentration and stay *on Line*, but try to stay *off the brakes* as much as possible. If you have an instructor, he or she will help you determine the correct speed.

You'll know you're entering the cool down lap when you see the Checkered Flag. Be sure to acknowledge the flag by waving or blinking the headlights, as noted above. There is no passing after the Checkered Flag.

Note: Any variations regarding the use of the Checkered Flag will be announced during the morning driver's meeting.

- **Track Exit.** At the completion of the cool down lap, raise your left fist high out the side window as you approach Flag Station 10 (the Downhill), and keep it there until you reach Pit-In. You'll leave the track by means of Pit Lane (5 mph speed limit), where Pit-Out Marshals will direct you into the Paddock area.
- **Parking.** Your brakes will be very hot when you exit the track. If you use the brakes to completely stop the car, heat will transfer from the rotors through the pads into the calipers, causing the fluid to overheat. Excessively hot brake fluid sucks water vapor from the atmosphere, which can cause sponginess in the brakes, and, in severe cases, brake failure.

Here's how to park. Use the brakes to *almost* stop your car. Then release the brake and let the car roll a foot or two before coming to a complete rest (this leaves a small air gap between the rotor and the pads). Park in gear and *don't use the handbrake*. If you're driving a Turbo, also leave the engine running for at least a minute to cool the oil and bearings.

If you have an instructor, try to take a few moments to review the just completed Track Session and discuss areas in question for your next Session. If it helps, look at the layout again (**Appendix D**) to go over each portion of the track. Also use the time between Sessions to make mechanical checks -- e.g., oil and brake fluid levels, as well as the condition of your tires, brake pads, lug nuts, etc. Make a point of always knowing the condition of your car.

Pit-In / Pit-Out Work Assignments

The control of vehicles entering and exiting the pits plays a critical role in safety, Staging and the conduct of Track Sessions. All drivers, except instructors and track workers may be required to perform Pit-In / Pit-Out Assignment during the day. If selected, you'll receive your assignment during morning check-in.

The schedule you'll receive at registration will indicate the starting time of your Pit-In / Pit-Out Assignment. Your Pit-In / Pit-Out Assignment will last about one hour, so it's a good idea to think about the weather, bug repellent, and drink, etc. ahead of time. Make sure you're not wearing yellow or red (including caps and umbrellas), and remember that minors and pets are *never* permitted at Pit-In / Pit-Out. Orange work gloves are recommended in order to give drivers clear stop/go hand signal instructions. Arrive at your assigned on time as the workers already on duty can't leave until you arrive.

Pit-In Marshal

As the Pit-In Marshal, you are responsible for releasing the Run Group from Staging on to Pit Lane. Since cars entering and leaving the track all use Pit Lane, pay close attention and only release cars from Staging on to Pit Lane when it is safe. Review CVR DE Regulations BEFORE you report for your work assignment.

Pit-In Procedures:

- Once you arrive at the Pit-In station, radio Control as soon as possible that you (and the others in your group) are at the Station, and provide the name of each worker.
- Approximately 10 minutes before the next run session begins, Control will radio you instructing you to release the next run group into the hot pit. You have the responsibility to check each car's compliance with **CVR Drivers Education Regulations (Appendix B)** as it

related to on track activity. You may hold a car at Pit-In until you have determined they are in compliance.

- Ask (use hand signals and point to your left wrist as car approaches) the occupants to display run group wristband. This wristband identifies the driver as registered for the event. The color indicates the driver as approved to drive with a specific run group. Drivers must display the appropriate color wristband for the upcoming run group. Instructors must display a red wristband.
 - CVR approved Instructors riding in student cars and students riding in a CVR approved instructor's car for instructional purposes is permitted.
 - No student may ride with another student.
 - Non-participants are not permitted in either student or instructor cars.
- Drivers and Instructors must put on all safety equipment before being released from Staging to the Pit Lane.
 - Release cars on to Pit Lane only after occupant(s) are firmly and correctly belted into the vehicle and the occupant(s) helmet are secured. All open car drivers (including cabriolets and open Targas) must have face shields or goggles. Eye protection is recommended for all participants.
- Check that all participants are wearing long pants and a shirt (Natural, not synthetic fibers).
- Check that ALL sunroofs are closed. Check that all doors and hoods are secure.
- Driver side and passenger side windows must be fully down. Use of a window net is permitted only if the driver can give proper passing signals.

Pit-Out Marshal

The Pit-Out Marshal is stationed at the end of Pit Lane. You are responsible for releasing the Run Group from Pit Lane on to the Race Track. As the Pit-Out Marshal, you have the best field of vision to know when it's safe to release cars on to the Track. As the Pit-Out Marshal, you have the responsibility of controlling the release of cars on to the Track. Review CVR DE Regulations BEFORE you report for your work assignment.

Pit-Out Procedures:

- Once you arrive at the Pit-Out station, radio Control as soon as possible that you (and the others in your group) are at the Station, and provide the name of each worker.
- Line up the Run Group single file, on the Track side of Pit Lane (left side at Lime Rock).
- Once in line, walk up the line of cars to make a final check – side windows down, sun roof closed and check that your seat belt and helmet are securely fastened.
- **Track Entry.** When Control is satisfied that the track is clear, you will be instructed to release the Run Group on to the Track.
 - Clearly Signal EACH car on to the Track. Drivers are instructed to wait for *their* signal before entering the track.

- Be aware that cars toward the back of the line on Pit Lane may be released on to the Track when other cars are completing their first lap.
- **Track Exit.** At the end of the Run, the Pit-Out Marshals will direct cars into the Paddock area.

IV. TRACK DRIVING BASICS

It doesn't really matter whether you're on a driveway, a highway or a super speedway. The *basic laws of physics* governing your Porsche's handling never change. However, the *effects and consequences can be quite different* when driving your car closer to its limits in a track setting. That's why the Driver's Ed experience *can feel so different*. No matter how skilled and careful you are on the street, additional attention must be paid to technique and safety.

This section of the guide is intended to acquaint you with some of the basic concepts and terms we use in Driver's Ed, so that you'll be able to communicate more effectively at the track.

Driving Position and Mirror Adjustment

Most of us have seen pictures of the great straight leg - straight arm drivers of the past, as well as more recent legends, like Richard Petty, who sat amazingly close to the steering wheel. Neither position is recommended. Driving with your arms and legs fully extended increases fatigue and complicates turning and pedal movements. At the other extreme (i.e., crowding a Porsche steering wheel), it's also difficult to operate the controls or glance easily at the gauges.

While on the track, your hands normally will be at the 9 and 3 o'clock position, with *both hands on the wheel except to shift or signal*. Here's a simple method that should get you fairly close to the optimum seating position for your car and build:

- If your seat has a vertical adjustment, place it as low as possible without sacrificing your field of vision through the windows. In general, you can feel the road better by sitting lower. Also, for taller drivers, bear in mind that many Porsches have fairly low headliners (your helmet adds an inch or two to the top of your head).
- Move the seat so that your knees are slightly bent when the pedals are fully depressed. [Alternative method: move the seat so that you can fully depress the clutch with your *right foot* when your *right leg* is fully extended]. If your seat bottom has a front tilt adjustment, you might want to dial in a little thigh support while you're doing this.
- Adjust the incline of the seat back so that your elbows are comfortably bent when gripping the steering wheel at 9 and 3. [Alternative method: adjust the seat back so that your wrists are even with the top of the wheel when both arms are fully extended]. When this is complete, you should be able to slide your hands 90 degrees or more around the steering wheel – as if making a turn – *without losing back or shoulder contact with the seat*. Contact with the seat back, like sitting low, tends to improve road feel.

Reposition the mirrors *after* you've completed the seat adjustment. Since most passing at Lime Rock Park Driver's Ed program is on the right (except as noted earlier for Red Run Group drivers), pay special attention to your field of vision near the right rear fender.

Check with an instructor -- before getting out on the track -- if you're unsure about this.

Entering and Exiting the Track

- **Entry.** When the Pit-Out Marshal signals you onto the track, look back (along the track) to make sure it's clear. Then accelerate in a brisk but controlled manner staying to the right side of the track. You'll be approaching Big Bend -- the sharpest corner on the course.

Never assume the track is clear. Check your mirrors frequently for oncoming traffic, and stay to the right at least through Flag Station 2. Then, if it's safe, move smoothly out to the Line from there. If another car is approaching too quickly or too closely, continue staying to the right until it's safe to pick up the Line at a later point.

- **Exit.** When leaving the track, signal Flag Station 10 (as well as nearby drivers) of your intention to do so by raising your left fist high out the side window. With your arm still extended, stay on Line through the Apex at the Downhill Turn, and then *stay to the right* as you decelerate toward Pit-In. Unless you plan to go right back out, stay to the right on Pit Lane and watch the Marshals. Remember, the Pit Lane and Paddock speed limits are 5 mph.

The Line

The correct driving Line is *seldom the shortest distance* from start to finish (unless you're on a drag strip). In general, the Line connects the longest straights to the smoothest and largest-radius turns. This permits you to accelerate longer on the straights, maintain higher average speeds while cornering, and achieve higher exit speeds from the corners that lead directly onto straights. These higher speeds more than compensate for the somewhat longer route. The Line also can vary according to weather conditions (e.g., wet vs. dry track), traffic and other factors.

Finding and driving the best Line involves utilizing the entire track – left to right and right to left – and it requires practice. A few general illustrations are provided in the **Cornering Section**. **Appendix D** illustrates the Lime Rock driving Line taught in the CVR Driver's Ed program and describes each section of the track. Don't worry if it seems counter-intuitive at first. Driving the Line is much easier to do than to read about. If you're with an instructor, you can count on a lot of coaching until you feel comfortable.

Deceleration, Braking, Shifting and Acceleration

One of the most important Driver's Ed fundamentals is to begin and complete *all* decelerating, braking and shifting maneuvers while your Porsche is moving *in a straight line and* the front wheels are *pointed straight ahead*. This is essential for both performance and safety.

- **Deceleration and Braking.** Lifting or applying the brakes (or doing both) transfers weight to the front wheels. This increases front traction and decreases rear traction. If you do this while turning in a high-speed situation, your Porsche will tend to oversteer. Oversteer makes the back of the car want to slip away from the arc of the turn -- a major cause of spins-outs.
- **Down Shifting.** The *only* purpose for shifting on the track is gear selection – finding a range to maximize torque and provide sufficient RPM's to stay below the red line. Down shifting while turning can cause sudden oversteer. Down shifting to slow down on straight stretches also upsets the car's balance, and it's very hard on transmissions, drive trains and engines. *Use the brakes to slow down, not the transmission.* For most beginners at Lime Rock Park, there won't be a great deal of down shifting on the track. However, if you plan to continue with track driving -- and don't know how already -- you'll want to learn the heel-and-toe technique for down shifting *as* you brake. It's beyond the scope of this Guide but worth discussing with an instructor.
- **Acceleration and Up Shifting.** Whether you simply press the gas pedal to accelerate -- or up shift and accelerate -- weight (or load) is transferred to the rear wheels. Generally, if you accelerate *gradually* while turning, the load transfer will increase rear traction and decrease

front traction, creating understeer. The “plowing effect” of understeer -- i.e., the car wants to go straight when you want it to turn in -- enlarges the radius of the car’s arc in the turn. In more pronounced cases, this makes it difficult to hold the turn or maintain control. If you accelerate *abruptly* while turning, the throttle force can overcome the traction capabilities of the rear wheels (i.e., the rear tires “un-stick”), causing the opposite effect – oversteer. As noted earlier, oversteer is a major cause of spins.

The physical effects of oversteer and understeer can be more (or less) pronounced depending on track geometry and surface conditions (e.g., uphill, downhill, banked surfaces, irregularities and bumps, slippery areas, etc.). If you have an instructor, you can count on extra coaching to help you find the best driving Line in these situations.

Cornering

As you practice and get more familiar with the track, you’ll soon realize that no two turns at Lime Rock Park are exactly alike. That’s part of the fun. The good news for beginners is that the *basic considerations* are pretty much the same for all corners. Once you know the fundamentals, it’s then a matter of application to meet the need.

The general idea is to go in slow and come out fast. Here’s the full sequence:

- **Look.** Locate the Turn-In Point and make sure you’re lined up.
- **Lift.** Let up on the gas pedal – car and wheels straight – to begin slowing down.
- **Brake.** Apply the brakes firmly but smoothly – again, moving straight ahead.
- **Shift.** Select a lower gear (where applicable) to maintain torque and enable quicker acceleration out of the turn – car and wheels still straight.
- **Off.** Release the brake smoothly.
- **Turn.** With *shifting complete and your foot off the brake*, initiate the turn at the Turn-In Point. The throttle should be balanced, not accelerating or decelerating. As you do this, look to the Apex. And, as you approach the Apex, re-direct your eyes to the Track-Out Point. Let your hands follow your eyes. With practice, you’ll learn to take most turns with two smooth sweeps of the steering wheel: one to initiate and carry you through the main arc, and the other to straighten the front wheels as you approach Track-Out and prepare for the next stretch.
- **Squeeze the Throttle.** To optimize balance (and traction), apply the gas evenly and consistently to maintain a constant speed as you begin to negotiate the corner. Depending on track conditions, corner characteristics and other factors, the precise point to begin accelerating varies somewhat from turn to turn. See **Appendix D** for a fuller discussion of the typical acceleration points at Lime Rock Park that are taught in the CVR Driver’s Ed program. Practice so that the transition from brake to throttle and the application of throttle are as smooth as possible.

Sound complicated? Like driving the Line, it’s much easier to do than to read about. At Lime Rock Park, most of the turns are much less involved because they don’t require shifting: LOOK

– LIFT – BRAKE – OFF – TURN – SQUEEZE (often referred to as “BOTS”). Depending on your speed, some turns may not even require braking: LOOK – LIFT – TURN – SQUEEZE. Needless to say, it’s essential to maintain the proper driving Line while cornering. Here are some simplified illustrations showing how to do this. In these illustrations, we’re assuming that straights precede and follow the turn. Turn-In is the reference point for initiating the turn. The Apex shows where the car should be mid-way (the transition point between entering and exiting the turn). Track-Out is the point where the car should be when it completes the turn.

Illustration 1 shows the *correct* Line for this type of turn. Notice the broad sweeping arc that utilizes the entire track surface. This permits the highest safe speed for this type of turn under normal conditions.

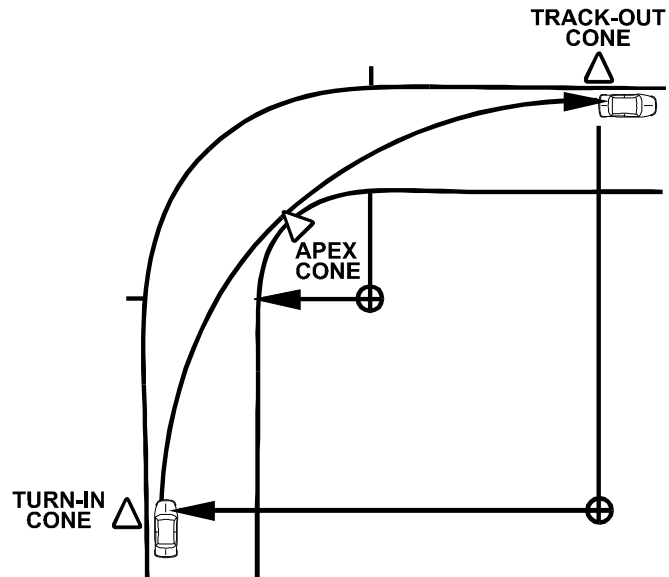

Illustration 1

Illustration 2 shows an *incorrect* way to make the same turn. In this case, the middle-of-the-road route and the shorter turning radius combine to slow things down. Every critical point was missed.

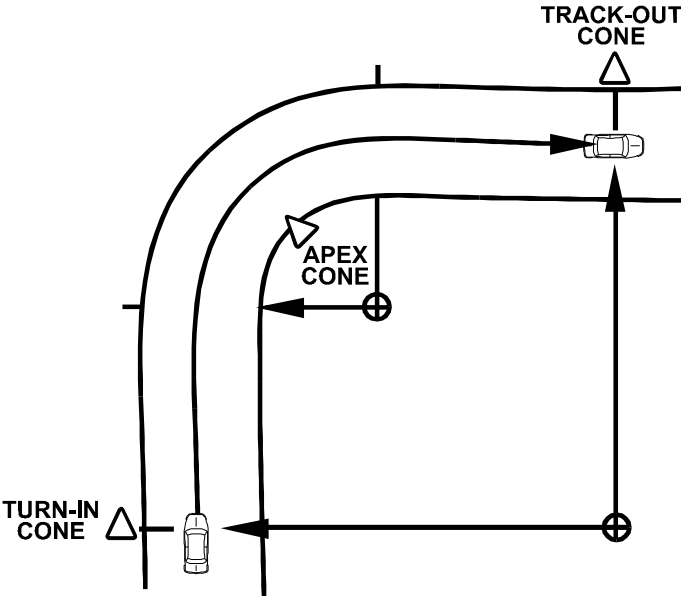

Illustration 2

The Driving Line at Lime Rock Park

The track map at **Appendix D** provides a bird's eye view of the Lime Rock driving line taught in the CVR Driver's Ed program. Succeeding pages at **Appendix D** describe the proper sequence for each turn.

Passing Maneuvers

When you receive the signal to pass, and it's safe, move smoothly to the right. Allow plenty of space as you go by, and don't pull directly in front of the car you're passing until you're well ahead. Use your mirrors.

Also use your mirrors to sense others following closely behind you. Don't create a bottleneck by letting a "train" of cars build up. Give a clear signal and let them pass -- safely, one at a time -- when you reach a designated passing zone.

When being passed, *stay straight on Line and lift temporarily* to make it easier for the other car to go by. Lifting is especially important when the car being passed has a lot more straight-line acceleration capability than the passing car (e.g., a 911 Turbo vs. a 914/4, etc.).

Avoiding Difficulties

- As noted earlier, the Flag Stations are your main connection with overall track conditions and the status of your Track Session. Learn to use peripheral vision to quickly recognize and react to signals without diverting primary attention from the track.
- Don't crowd the car in front. Except when passing, try to keep an interval of at least three car lengths on straights and three seconds in corners.
- Keep a safe distance from the edge of the track and any obstacles (including other cars) that may come into view. Try to get around obstacles without upsetting your car's balance more than necessary. If you hit something, and think your car is still perfectly driveable, come in for a pit stop anyway.
- If you spin out, immediately depress the clutch fully and apply the brakes hard enough to lock up all four wheels (if possible) until you come to a complete stop. This is the so-called "both feet in" rule, and it's generally the quickest and safest way to stop in a track environment. Spins require a pit stop.
- If one or two wheels leave the track, don't attempt to jerk the car back on or abruptly change speed. Overreacting can complicate things because of the uneven traction in these situations. Stay smooth, and try to do everything in small increments rather than big ones. If hugging a turn too tightly caused your predicament, reduce cornering demands by straightening the wheel. If you're going straight, slow down and continue straddling the edge of the track until you can safely coax the wheels back on or come to a stop. 2-OFF requires a pit stop.
- If your car heads all the way off the track (i.e., 4-OFF), immediately put "both feet in" *and* straighten the steering wheel. *Do not* re-enter the track until you are signaled to do so by a flagger or other track official. Flaggers can not motion a driver back onto the track until they receive clearance from Control. 4-OFF is a mandatory pit stop tech check once you're cleared back on the track.

Smoothness

You'll hear a lot about this from the instructors and other experienced drivers. Erratic accelerations, stabbing at the brakes, jerky gear shifts and over-use of the steering wheel all tend to unsettle the car's balance and cause unwanted oversteer, understeer and roll.

A smoothly driven car is generally much quicker and safer on the track, and it's a lot more fun to drive.

To Sum Up

If you're a first-time Driver's Ed participant, this may seem like a lot to think about and remember. It's all essential to promote safety and enjoyment. The techniques tend to become intuitive with a little practice and instruction.

If you're like most new participants, you'll be amazed how much you pick up the first day alone. Getting familiar with the basic concepts and terminology ahead of time will give you a big advantage when you arrive at the track, and will make the experience a lot more fun.

APPENDIX A: GLOSSARY

APEX: The area on the inside of a turn at which the car finishes the entry phase and begins the exit phase. The car must be as balanced as possible when it “clips” this point. *

BALANCE: The relative amount of weight -- or download -- at each wheel. Download changes -- front to back and side to side -- affect traction and handling as various forces are applied to the car (e.g., acceleration, deceleration, shifting, braking, inclines, variable road surfaces, etc.).

CONE: A traffic pylon used to mark various points on the track, such as Turn-In, Apex, Track-Out, etc.

CONTROL: The individual in the Michelin Building controlling the event and to whom flaggers report.

FLAGS, FLAGGING AND FLAG STATIONS: Section III, Appendix D and Appendix E.

FOUR-OFF (4-OFF): Four wheels off the edge of the track surface. This is sometimes referred to as an off-track excursion.

HEEL-AND-TOE: A down shifting technique used to match engine speed with transmission speeds, all the while continuing to brake. The sequence is: brake; clutch in; “blip” the throttle with the right side of the right foot; shift to lower gear; clutch out. Brake pedal pressure should remain constant throughout this sequence. *

LIFT(ING): Letting off the gas pedal.

LINE: The optimum path around the track. In corners, this path is usually the largest radius arc that can be fit into the confines of the turn. The Line can vary with track conditions and the type of car being driven. *

NINE & THREE (9 & 3) O’CLOCK: The basic steering wheel grip, when visualizing the wheel as a clock dial, with the left hand at “9” and the right hand at “3”.

OVERSTEER: In cornering, conditions in which front tires have more traction than rears, causing the rear of the car to point to the outside and the nose to point to the inside. *

POINTING (FLAG): The flag is held, *partially unfurled*, with one hand grasping the stick and the other hand stabilizing the flag surface. The flag is pointed at a specific car (i.e., Black Flag pit stop).

ROLL: Movement (or tilt) of the car which changes the ride height on the left or right of the vehicle’s centerline. *

RUN GROUPS: Five color-coded groupings used in the Driver’s Ed program that separate drivers according to their skill and experience levels. See Section III.

* Source: Skip Barber School

APPENDIX A: GLOSSARY (CONTINUED)

SPIN: Condition where the car rotated direction. Either on or off the track.

STAGING: At Lime Rock Park, the final preparations that occur on Pit Lane prior to sending the cars in a Run Group onto the track.

STANDING (FLAG): The flag is held *unfurled* with one hand grasping the stick and the other hand holding the outer edge of the flag surface. It is kept high and stationary -- facing oncoming cars -- to maximize visibility.

START-FINISH: A line across the track at the Start-Finish Flag Station.

TRACK-OUT: The point past a turn, typically at the far outside edge, at which the car has completed the turning stage and all the dynamic forces acting on the car are in balance. *

TRACK SESSION: A period when the cars in a particular Run Group are out on the track.

TURN-IN: The point at the entrance to a turn at which the driver first turns the steering wheel to initiate the cornering sequence. *

TWO-OFF (2-OFF): Two wheels off the edge of the track surface.

UNDERSTEER: In cornering, the condition in which the rear tires have more traction than the fronts, causing the fronts to slide across the road toward the outside edge rather than turning or pulling the car into the turn. *

WAVING (FLAG): The flag is held by the stick, *unfurled*, and waved *energetically* in a figure eight pattern toward oncoming cars.

* Source: Skip Barber School.

APPENDIX B: 2019 CVR DRIVER'S EDUCATION REGULATIONS

1. Participants must be at least 18 years of age, must have a valid driver's license, A current driver's license shall be shown at Registration. Because applications for participation far exceed available slots at our events, only PCA members driving Porsches may drive on the track. However, if the event is not sold out, other qualified driver's and vehicles may be allowed to participate. SUVs are not permitted.
2. Drivers MUST have completed BOTH registration and car tech PRIOR to the driver's/instructors' meeting or YOU WILL NOT BE ALLOWED TO DRIVE that day. Similarly any cars that are not pre-teched will not be allowed on the track that day.
3. Participants must wear a SNELL 2010 (SA recommended), or later, approved helmet. All open car drivers (including cabriolets and open Targas - see # 9 and 10) must have face shields or goggles. Eye protection is recommended for all participants.
4. Participants must wear rubber-soled shoes, long pants, and a shirt (Natural, not synthetic fibers).
5. Guests are welcome; if under 18 years of age, they must remain in the spectator areas and are not allowed on the track, in the pits, or on the flagging stations. If guest is a minor, a minor waiver must be completed and signed.
6. Non-participants are not permitted in either student or instructor cars. (Note: CVR approved Instructors riding in student cars and students riding in a CVR approved instructor's car for instructional purposes is permitted.) No student may ride with another student.
7. ~~On a space available basis, non-drivers may participate in a Taste of the Track for a fee of \$40. These "students" will be given an instructional ride with a CVR instructor at reduced speeds in either the Green or Yellow run groups. They will be expected to participate in all aspects of the Driver's Education program. Pre-registration is required. Participation is limited to once per individual per track.~~ **Discontinued**
8. Fire extinguishers are recommended ~~mandatory~~ for Red, Black and White run groups and must be securely fastened metal-to-metal (minimum 2 1/2 pound, two-strap metal bracket recommended).
9. All sunroofs must be closed.
10. All open cars, Targas and 914s must run with tops up unless they have a full roll cage.
11. All open cars, including cabriolets and Boxsters, must have a visible, approved roll bar which conforms to the following: With the occupant(s) (student and instructor, if applicable) firmly and correctly belted into the vehicle, the occupant(s) helmet must be below a straight line drawn between the top of the windshield and the top of the roll bar (clearance in a "Broomstick Test"). It is further recommended that roll bar be padded in any area that may come in contact with the occupant(s) helmet. Participation of open cars requiring instructors will be limited at each event based on the number of volunteer instructors who pass the "Broomstick Test".
12. Driver side and passenger side windows must be fully down. Use of a window net is permitted only if the driver can give proper passing signals.

13. All passes must be complete (passing car completely by the passed car) before the turn-in cone is reached. The car being passed must give a clear signal for each pass and is expected to lift momentarily to facilitate the pass. Passing zones will be communicated at the driver's meeting the morning the day of the event.

14. Students in an instructor's car or instructors in a student's car must have available the same restraint system as is being worn by the driver.

15. The stock factory occupant restraint systems with a 3-point shoulder/lap belt were designed and tested to protect occupants in a very effective fashion. However, these SYSTEMS are designed to be used only in conjunction with the stock seat. If additional support is desired, these SYSTEMS can be supplemented by a simple 3" lap belt. The lap belt may be used with the Factory 3 point shoulder/lap system. The additional lap belt should be secured before fastening the Factory belts.

While not required, some participants install harnesses. If the participant installs a 5/6 -point driving harness, several additional changes should be made in order to create a truly safe occupant restraint SYSTEM. Harnesses must include a sub strap and be mounted in an approved manner consistent with SCCA requirements and the manufacturer's instructions. A seat designed to be used with a harness must be properly installed in accordance with the manufacturer's instructions. This means that a seat is required to have the proper routing for the harness, both through the back and base of the seat for the respective shoulder and anti-sub belts. Shoulder straps should be mounted at 90 degrees to the axis of your spine or at most 40 degrees down from the horizontal. Because the addition of the harness means that the occupants are fastened upright in the vehicle, a roll bar or roll cage is strongly encouraged to complete the SYSTEM. The use of one without the other may result in an unsafe environment and is not a complete SYSTEM. If the car has harnesses installed, a Head & Neck Restraint System (HANS) must be used.

Installation of an incomplete safety SYSTEM, for example properly installed harnesses without a roll bar or roll cage, may result in instructor's electing not to provide instruction in the car. Participation in the event as a GREEN student or individuals not signed-off could be limited to number of instructor's electing to instruct in such an equipped vehicle. Additionally, signed-off students who seek instruction may also be impacted based on the availability of instructors willing to instruct in such an equipped vehicle

16. Street tires must have a minimum tread depth of 2/32 completely around at least two grooves (excluding wear bars). R-rated tires and slicks must have visible tread indicators around the full circumference.

17. Each participant, including Instructors, will run in one run group only. Exceptions must have the approval of Event Chair and/or Chief Instructor.

18. There is a mandatory Black Flag pit stop for a spin or 2-off. Two Black Flags for these or other driving infractions in a day are basis for no further driving for that day. (Work assignments must still be fulfilled.)

19. No alcoholic beverages or illegal substances may be consumed by anyone (participant or guest) during the event.

20. Pets may or may not be allowed on the grounds (if allowed, must be leashed at all times) depending of the facility used for the event. (Participants should remind invited guests of this regulation).

21. Stick on or magnetic numbers are mandatory in the yellow run group and above. They must be a minimum of four (4) inches high, be in a contrasting color to the car, and be placed on both sides of the car.

22. On a limited space-available basis and where applicable, garage spaces may be rented. Where applicable, fees and registration information will be on the CVR DE website or on ClubRegistration.net. Stalls will be assigned to participants on a first-come, first-served basis, or other method as determined by the Registrar (i.e., lottery).

23. Participants certify that they have no physical or mental impairments that might jeopardize themselves or others through participation in the event. Limitations impacting two-way verbal communication with an instructor, operation of foot pedals, gearshift and steering wheel, and use of hand signals for passing are examples of impairments, which might prohibit participation under this rule. A participant must notify the Registrar and Chief Instructor of any such limitation prior to the event. If the limitation can be reasonably accommodated (for example, by the use of turn signals in lieu of hand signals with an announcement made to other participants at the driver's meeting) in the sole discretion of the Chief Instructor and Event Chair, participation in the event may be allowed.

24. Vehicle will comply with any applicable local sound or noise restrictions.

25. The CVR VP, Driver's Education reserves the right to suspend and/or exclude from participation any entrant or guest who fails to display the behaviors consistent with these rules and the goals of CVR's Driver's Education program.

26. CVR DE Cancellation and Refund Policy

Advanced notification by e-mail (deregistrar@cvrpca.org) to the Registrar is required for all cancellations. If notification is not provided, scheduled attendance to the next DE event will be forfeited. A \$20.00 cancellation fee will be deducted from the refund.

Refunds and/or credit towards another DE event will not be granted for cancellations that are received by the Registrar less than two weeks prior to the event. Cancelling on ClubRegistration.net does not qualify as a notice to the DE Registrar. Refunds and/or credit towards another DE event will be not granted for a stopped event once a car has been on the track.

Consideration for a refund and/or credit toward another DE event will be not granted for "no-shows" unless the event was canceled by the track or CVR prior to the day of the event. Any fees incurred by CVR due to PayPal chargebacks are payable by the driver that incurred the fee.

For an event cancelled by CVR or the track, refunds and/or credit toward another DE event may be granted, at the Board of Directors' discretion, when an event is not started or the event is canceled either by the track or CVR prior to the start of the event. This only applies to those who show up at the event.

Check our Web Site at www.cvrpca.org

APPENDIX C: LIME ROCK AREA MAP

From Hartford: Take Rt. 20 West to Rt. 219 (left turn) to Rt. 318 (right turn) to Rt. 44 West. Take 44 to Rt. 41 South to Rt. 112 East.

From Danbury: Take Rt. 7 North to Rt. 112 West.

From Albany: Take NY Thruway (Rt. 87) South to Rt. 90 East and take Exit 2. Follow Rt. 102 West to Rt. 7 South to Rt. 112 West.

From New York City: Take the Major Deegan to NY Thruway North to Rt. 287 East to Rt. 684 North (which becomes Rt. 22 North to Millerton). Take Rt. 44 East to Rt. 112 East.

From New Jersey: Take the NY Thruway to Exit 17 East on Rt. 84 to the Taconic Parkway North to Rt. 199 East to Rt. 44 East to Rt. 112 East.

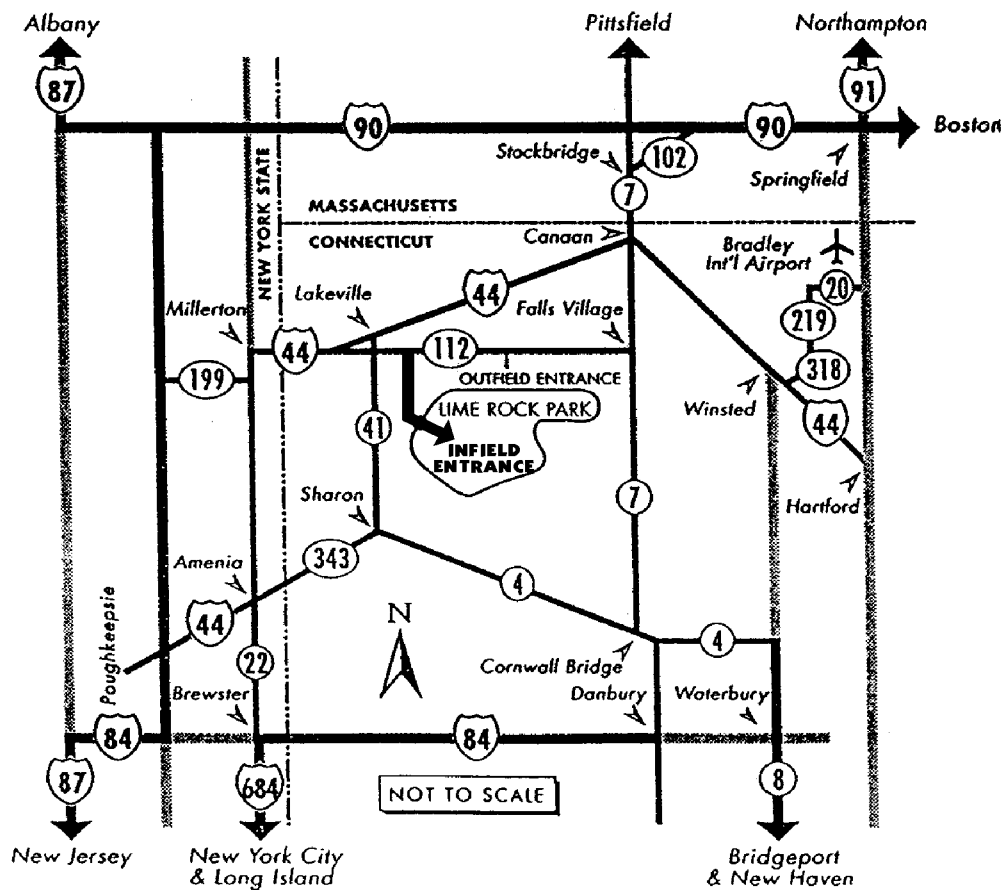

APPENDIX D: LIME ROCK TRACK LAYOUT

APPENDIX D: LIME ROCK PARK TRACK LAYOUT - 1.53 miles

(not to scale)

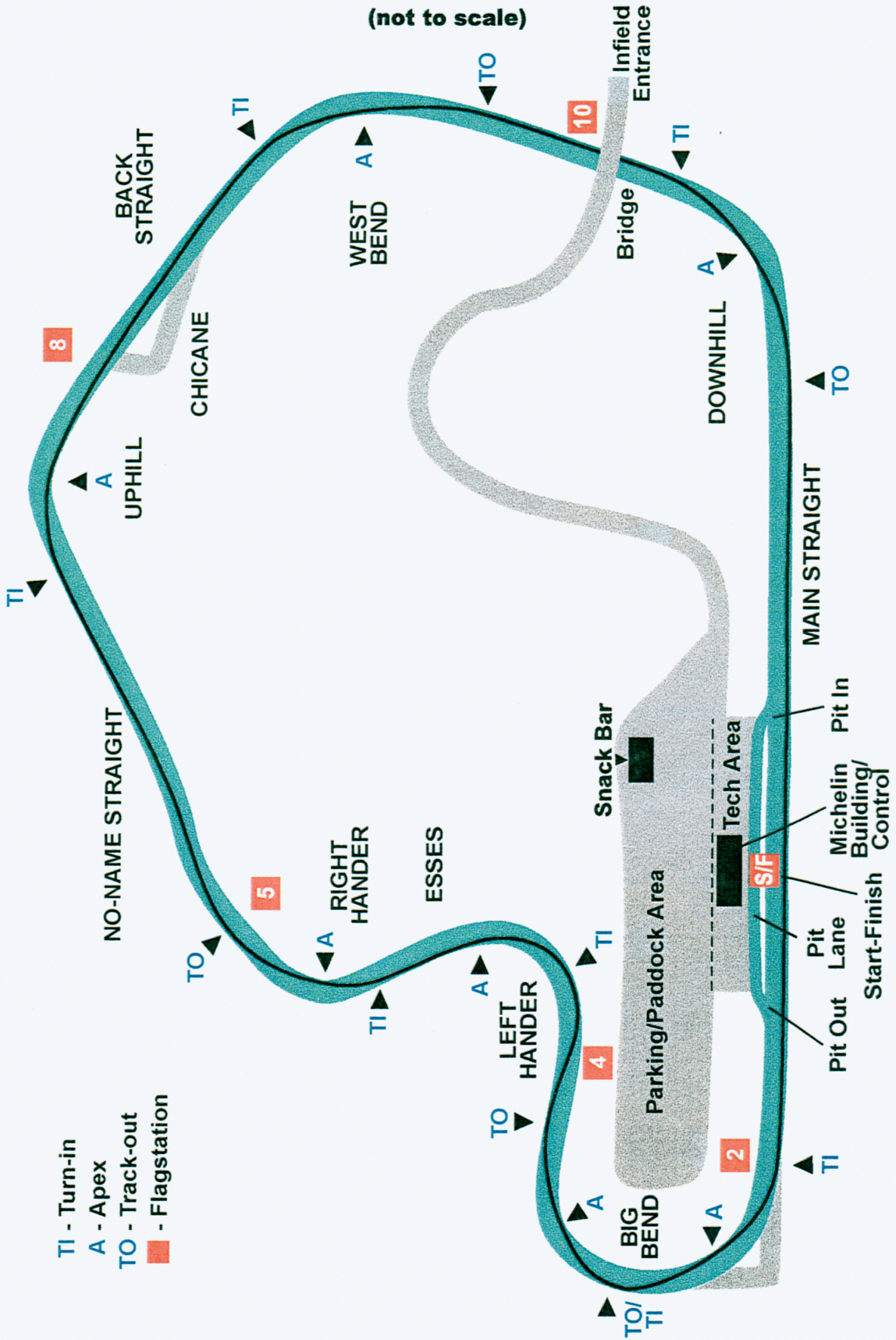

- TI - Turn-in
- A - Apex
- TO - Track-out
- - Flagstation

LAPPING LIME ROCK – THE CVR LINE

By Jim Adelman

2005

After receiving the signal from the pit-out marshal to enter the track, always check the main straight **yourself** to verify it is safe to proceed. Stay to the extreme right as you enter the track and accelerate gradually into the first turn. Remember to complete this first lap at reduced speed to warm up the car, yourself and study the track conditions. For the first run of the day, Yellow flags will be displayed at the corner stations being used. Look for them as they are your eyes to conditions on or around the track that you may not be able to see.

As you cross the start/finish line after your warm up lap, move to the left side of the track as you approach turn one, *Big Bend*. Referring to the braking numbers on the left for guidance, brake firmly until the car is stabilized. Complete your braking and downshifting in a **straight** line. Look through the corner for the first apex. Allow your hands to follow your eyes as you transition from the turn-in into the corner. **Balance the car with** neutral application of the throttle to keep the car stable, follow the line across the track to the first apex on the right side of the track. Position the car to clip the right inside apex. The car's momentum will carry you out to the left outside of *Big Bend* and to the second turn-in point located on the left edge of the track. Give yourself several feet of leeway from the outside edge. As you reach this turn-in point, look through the corner to *Big Bend's* second apex on the right inside. Maintain balance with the throttle as you tighten the radius of your turn, clipping the right inside apex, as you **gently** squeeze on the throttle. The car's momentum will carry you across to the track-out point on the left outside of the track. Remember that the corner is a decreasing radius that is the second half of the corner will be tighter than the first half. As the car is the most stable under acceleration or neutral throttle, you should be setting your speed into the corner in anticipation of the speed needed for the second apex.

Look ahead to the entry to turn two, the *Eases*, the only left-hand turn at Lime Rock. The line crosses the track from the left to the right. A good visual target reference is the restroom building straight ahead of you. As you approach the *Left-Hander*, brake in a **straight** line before the turn-in point on the right outside of the track. You don't have to be at the extreme right edge of the track to begin this turn, several feet in from the edge is a good starting point.

Balance the car with neutral throttle (not on, not off) as you look through the corner to the left inside late apex. You should hold your position on the right edge of the track long enough to be able to cross over the track and clip the left side late apex. Let your hands follow your eyes as you turn left to enter the corner. This is a throw away corner, instead of tracking-out to the right, stay to the extreme outside **left edge** of the track, in position to turn right into turn three, the *Right-Hander*, and the second part of the *Esses*.

Ease off the throttle, to scrub some speed and put weight onto the front of the car as you approach the turn-in point, look for the *Right-Hander* inside apex as you turn right and **smoothly** squeeze the throttle. Clip the apex on the right inside of the track, and allow the car to go to the track-out point on the left outside of the track which begins *No-Name* straight. As you approach the track out point of the right hander, notice that the road has a crown in it. After about 2/3 of the way through the corner, the road surface will be slightly falling away from you. This will result in less grip to the car.

Drive as straight a line as possible on *No-Name* straight as the track curves right then left as you accelerate toward turn four, the *Uphill*. Depending on your speed and car, you may want to shift gears.

As you approach the *Uphill*, stay to the left side of the track and brake in a **straight** line to stabilize the car as you approach the turn-in point. Look through the corner as you turn right, and smoothly squeeze the throttle to accelerate through the apex and onto the face of the *Uphill*. The car's suspension compresses and gives you increased adhesion as you go up the hill. Position the car to end up at the top of the hill with your right wheels on the **centerline** of the track. The car's suspension will de-compress as it crests the hill, and in some instances a car may spin its wheels at this point. Therefore, it is very important to keep the wheel **absolutely straight** as you crest the hill, even if you are coming up at an angle. You will have plenty of room to straighten out once over the crest and squarely back on all four wheels.

Once settled, aim directly for turn five, *West Bend*. Move to the left edge of the track as you near the end of this short straight, brake in a **straight line** to stabilize the car, and look through the corner. As you reach the left side turn-in point, let your hands follow your eyes as you squeeze the throttle and clip the right inside apex. Allow the car to cross over to the left outside track-out. Depending on your car's gearing, you may want to shift **after** you track-out.

You're now approaching the bridge and turn six, the *Downhill*. Stay to the left as you pass under the bridge. Brake enough to stabilize the car as you go down the hill. Be sure you are completely **off** the brake before you reach the bottom of the hill. The left edge of the track veers slightly to the left as it goes down the face of the hill, but keep the car **straight** as you go down the hill. The left edge of the track comes back to the right to meet you at the turn-in point at the bottom. The car gains adhesion as the suspension compresses at the bottom of the hill, allowing you to squeeze the throttle as you turn in. Look through the corner, clip the right inside apex, and continue to the left outside track-out of the *Main Straight*. There is no need to ride the extreme left edge of the *Main Straight*. Bring the car in a comfortable distance from the left edge. Depending on your car, you may want to shift gears as you accelerate down the straight through the start/finish line towards turn one, *Big Bend*. Here you begin again and get the opportunity to correct the mistakes you made on the previous lap!

JA, 2005

PALMER MOTORSPORTS PARK TRACK LAYOUT

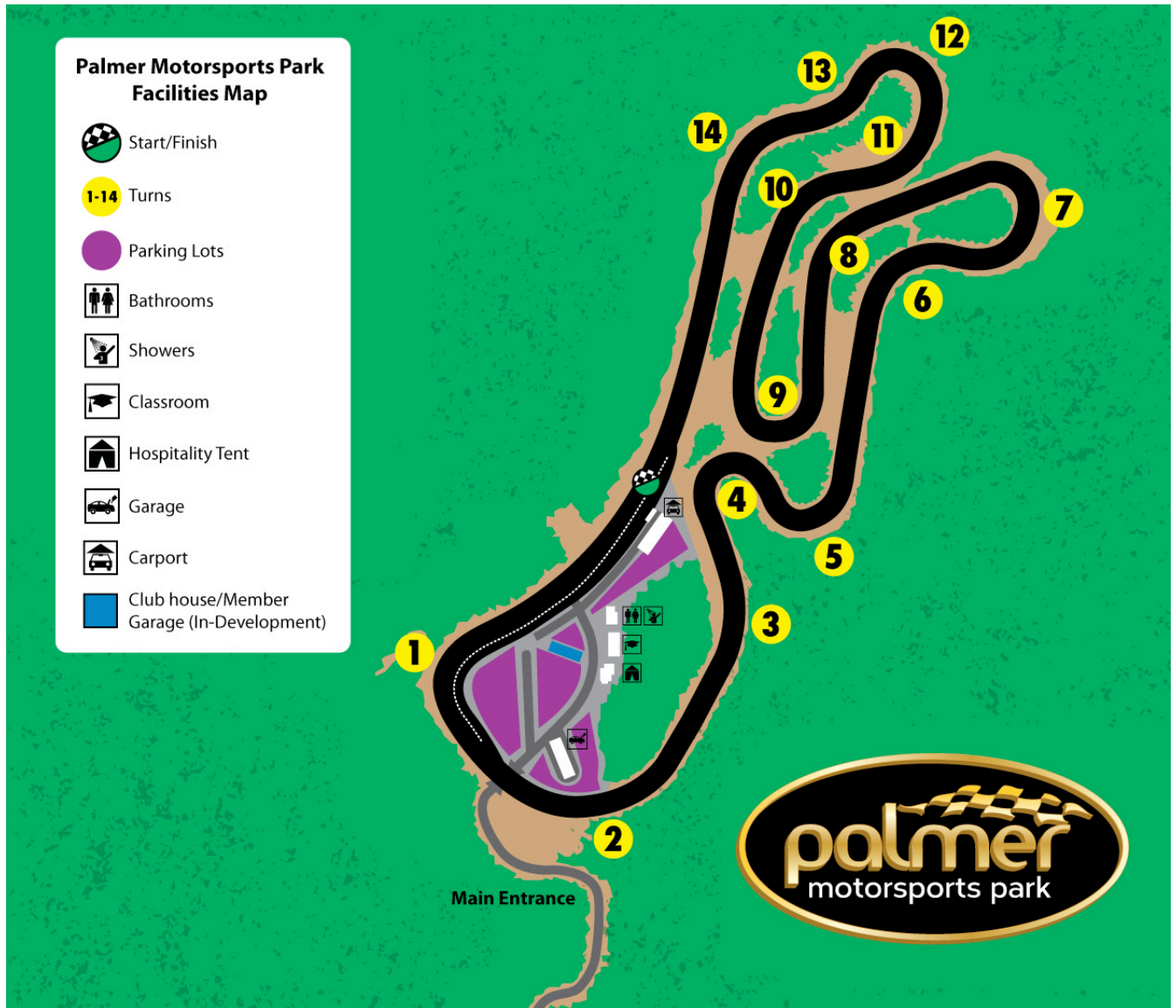







APPENDIX E: FLAG STATION COMMUNICATION INSTRUCTIONS & FLAGS AND THEIR USE

**Please note that CVR no longer provides flaggers for events. Flaggers are now hired.

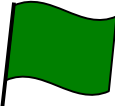
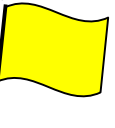
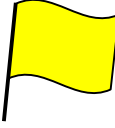
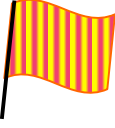
Each flag station should have one radio communicator and at least one flagger. The radio communicator runs the radio communications and relays instructions to the flagger(s). One person must be looking up the track, and one person must be looking down the track at all times. The flag station's responsibility is to inform the drivers of track conditions at and beyond the station. The flagger shall display the appropriate flag(s) as determined by events at and beyond the station and instructions from control. In the case of a waving yellow "display" means a forceful figure-8 motion. The intensity of the waving yellow informs the drivers of the severity of the situation. When no flag is being displayed, the flagger should have the yellow flag in hand, but out of sight from the drivers.

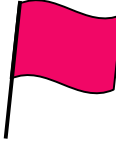
Radio communication reminders

- Always give station identity and flag status when calling control
- Wait with reply until control asks for input
- Describe what is happening as brief and precisely as possible
- Talk in a steady and controlled pace (be unexcited even if there is action in front of you)
- Acknowledge control's instructions, and sign off when through with current communication
- Never argue or make any negative comments over the radio

Flag Description	Meaning of flag	Use as follows	
Green		Indicates a “Clear track”	Displayed at designated flag station(s) only
Yellow		“Caution flag” Indicates that a vehicle is off the track near or beyond the flag station	Display as soon as situation develops, report to control. Remove when directed by control
Waving Yellow		“Caution, immediate danger” Indicates that the track is partially or fully obstructed thus creating a dangerous situation	Display as soon as situation develops, report to control. Remove when directed by control
Yellow with Red stripes		“Changing track condition” , also called the “slippery track” flag	Display as soon as condition occurs, report to control. Note: this flag should only be displayed when the track condition has changed (such as when dirt or fluids have come onto the track, or when rain has started to fall).
Black (shown to a particular car)		“Come into the pits”	Display on order from control Be firm and precise when showing it to a specific car. Display so that full face of flag is visible to driver, then point to the specific car. Look for the driver to acknowledge flag. Remove as soon as car passes
Black (when shown at all stations)		“All cars come into the pits” A “black all” condition	Display and remove on order from control
Red (shown at all stations)		“Emergency” All cars must come to a safe, immediate and controlled stop near the edge of the track, and off line in sight of the next flagging station	Display and remove on order from control
White (shown at all stations)		“Other or slower vehicles on the track”	Display and remove on order from control
Blue w/Yellow stripe (shown to a particular car)		“Check your mirrors” A car is behind you. The “passing flag”	Display distinctly to any car which has traffic close behind
Checkered Flag		“End of session” The cool down lap begins	Displayed only at designated checkered flag station(s) on order from control

APPENDIX F: WHAT TO BRING AND WEAR

What you *must* bring:

- Valid driver's license
- Completed and stamped tech sheet
- Helmet -- Snell 2010-rated or later model (unless arrangements made to use Club loaner)
- Clothing appropriate for the track:
 - Natural fiber garments such as cotton or wool (i.e., no synthetics)
 - Shirt(s), sweater(s), jacket(s), etc.
 - Long pants
 - Rubber soled shoes (see **Section II**)

What you'll *want* to bring (depending on weather and preference):

- This booklet
- Parts and supplies
- Engine oil
 - Brake fluid
 - Brake pads
 - Window cleaner
 - Paper towels
- Tools
 - Tool box
 - Lug nut socket
 - Torque wrench
 - Tire pressure gauge
- Magnetic or stick-on numbers (stick-on numbers supplied at Final Tech if needed)
- Clothing (depending on weather)
 - Rain gear, umbrella
 - Extra jacket, coat or sweater
 - Warm gloves
 - Neck support
 - Hat
 - Sunglasses
- Other items
 - Weatherproof storage items (ground cloth, tarp, plastic container, etc.) for your gear
 - Bug spray
 - Sunblock
 - Snacks and/or lunch
 - Water or other fluids to prevent de-hydration
 - Cooler for perishable food items
 - Camera